

APV-10

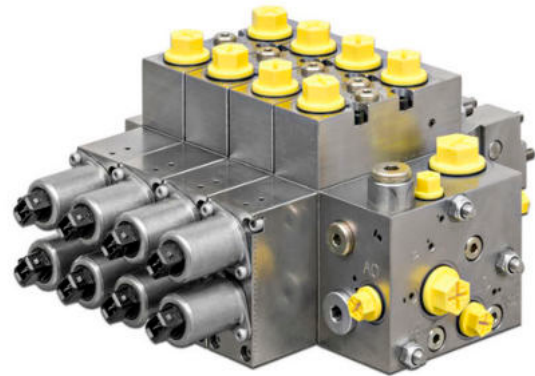

front



back

- Modular assembly system, suitable for 'Build Program'.
- Maximum operating pressure 350 Bar / 5076 PSI
- Different spool types up to 80 L/min / 21 GPM
- Compact sandwich design, suitable for mobile applications.
- Pressure compensated for simultaneous multi users.
- Several inlet plate types available for different types of pumps.
- Operating control in any combination (Electric-, Hydraulic and manual).
- Adjustable ΔP for setting the maximum flow for maximum proportional range.
- Several user port option functions.
- Designed for customisation.

Index:

Main technical data.....	3
Overview.....	4
Inlet section.....	5
Control section.....	7
Connection block.....	12
End plate.....	15
General dimensions (in mm)	17
Performance curves.	18
Recommended spare parts breakdown	22



Main technical data

Max. flow:	Port P1 or P2	100 L/min.	26 Gallons/min
	Port P1 + P2	160 L/min.	42 Gallons/min
	Port A / B	80 L/min.	21 Gallons/min
Max. pressure:	Port P / A / B	350 Bar	5076 PSI
	Port T	35 Bar	508 PSI
Pressure setting range		14-350 Bar	205-5075 PSI
Pressure drop over 2-way compensator (A,B)		3-12 Bar	44-175 PSI
Internal pilot pressure supply		28 Bar	406 PSI
Pilot pressure for electric and hydraulic control		6-20 Bar	87-290 PSI
Spool stroke		7 mm	
Spool overlap (dead band)		1 mm (13% of spool stroke)	
Fluid		Mineral oil according to DIN 51524/51525	
Fluid temperature range		-30°C...+80°C	
Viscosity range		10...500cSt, optimal 30cSt	
Contamination level max.		According to NAS 1638 Class 8 or ISO 4406: 18/16/13	

Port connections

Port P, T	G ¾" BSP	12" ORB
Port A,B	G ½" BSP	10" ORB
Port Ls	G ¼" BSP	6" ORB
Port L	G 1/8" BSP	4" ORB
Port YA,YB	G 1/8" BSP	4" ORB

Electric connection

Nominal voltage	AMP Junior Power Timer / Deutsch 12 VDC or 24 VDC
Nominal current	12 VDC (1500 mA) 24 VDC (750 mA)
Coil resistance	12 VDC (4,72 ± 5% Ω) 24 VDC (20,8 ± 5% Ω)
Recommended dither frequency	100 Hz
Type of protection	IP 65
Duty cycle	100%
Hysteresis	4%



Overview

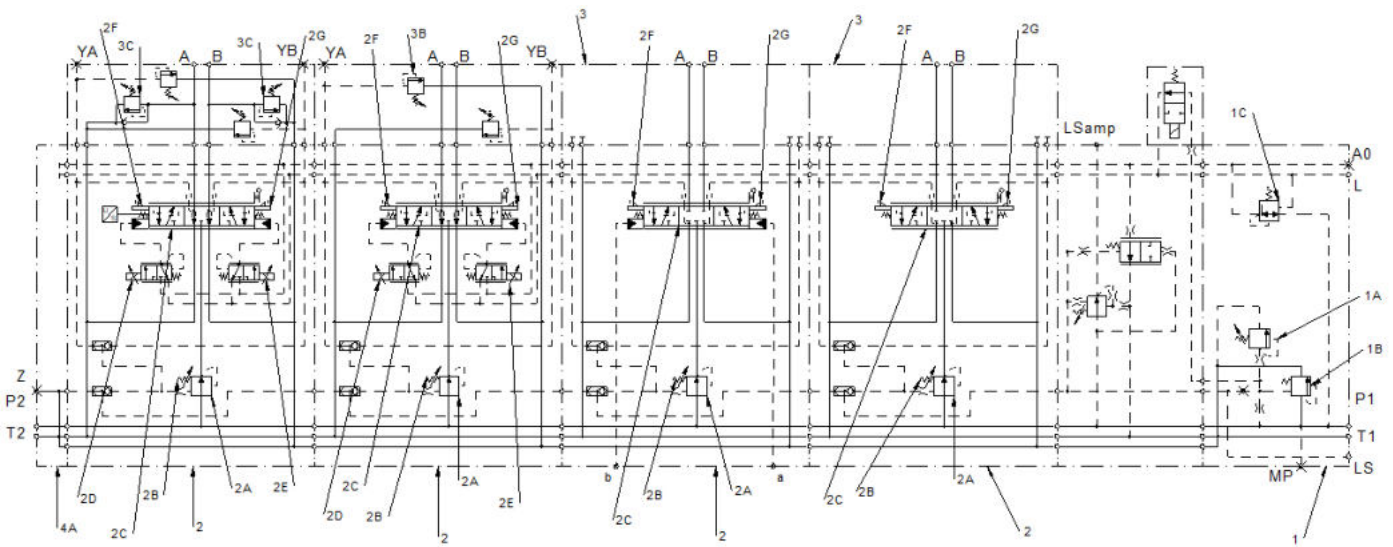

- 1, Inlet plate
- 1A Adjustable pressure relief
- 1B, Inlet compensator/3-way compensator
- 1C Pilot pressure reducing valve
- 2 Control section
- 2A 2-way compensator
- 2B Delta P adjustment
- 2D solenoids A side
- 2E solenoids B side
- 2G stroke limitation A
- 2F stroke limitation B
- 2C Main control spool
- 3 Connection block
- 3B LSa LSb adjustment
- 3C Shock suction valves
- 4 End plate, P2 and T2

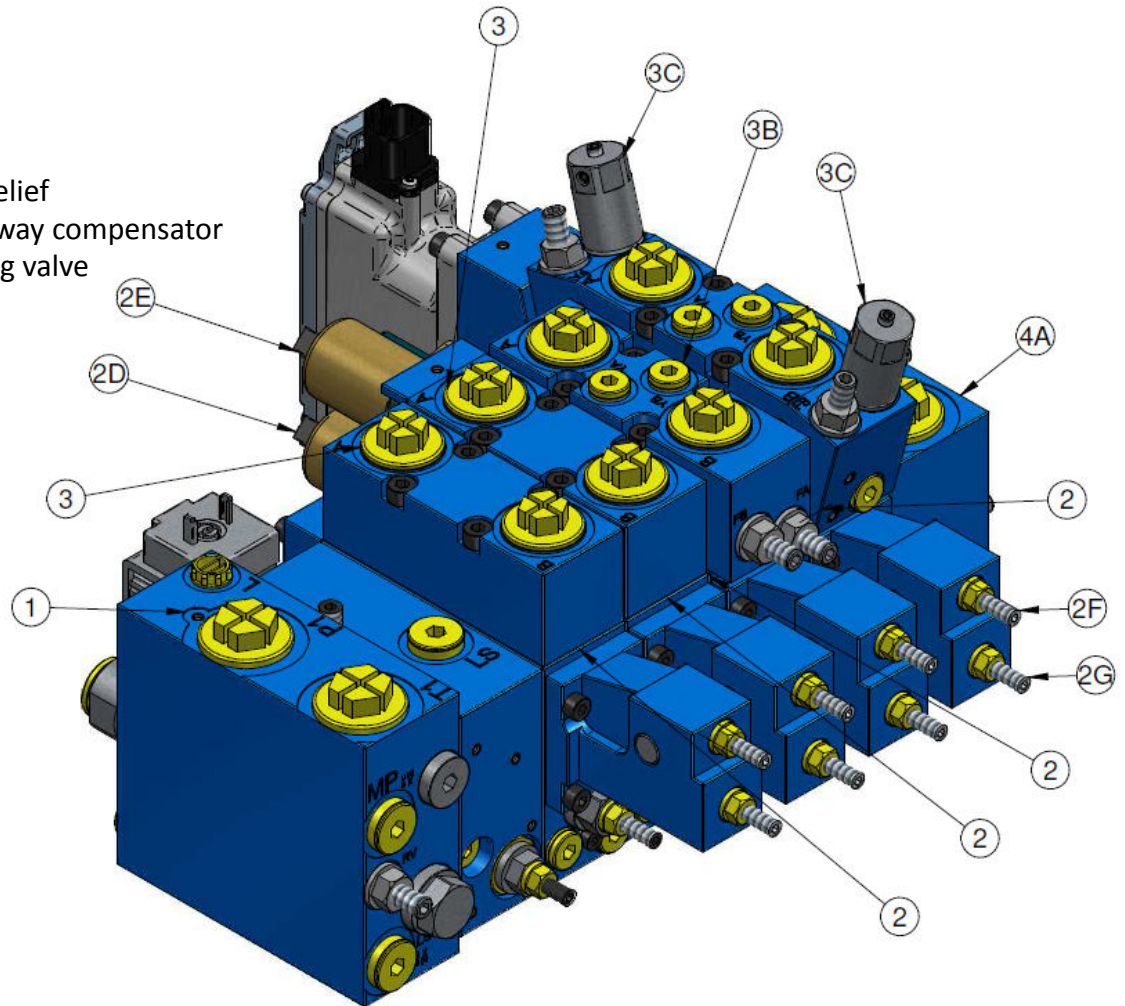

Inlet section

Inlet plates are available for fixed and variable displacement pumps, and constant pressure networks. Pilot pressure reducing valve for pilot pressure is included. Interchange plug and orifice to change between UJ and SJ is reachable from outside. P & T ports are $\frac{3}{4}$ " BSP or 12" SAE ORB.

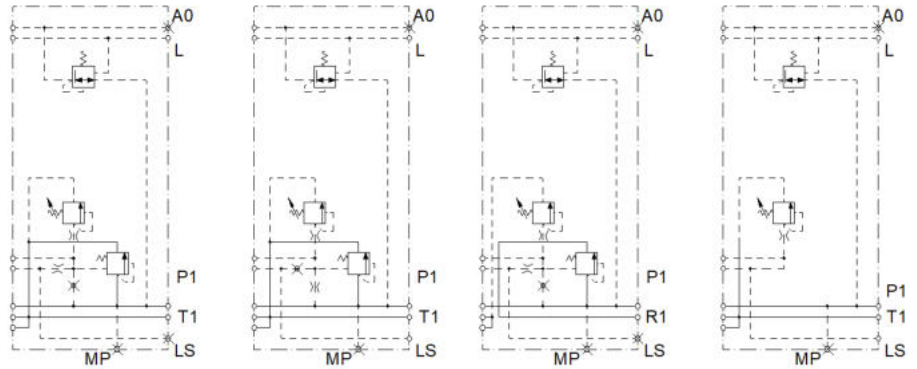
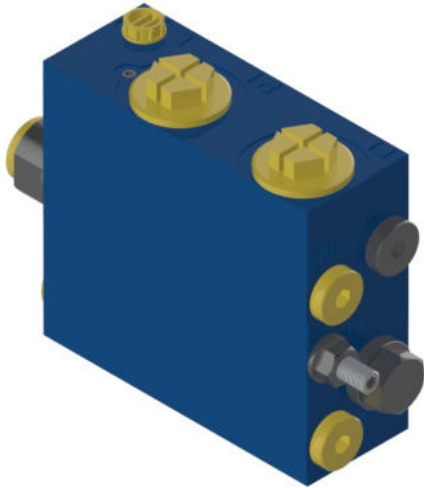

Inlet plate options:

Direct on the 1st side of the APV-10 an Anti-saturation with LS amplifier block can be mounted. (Optional extras are; Pump unloading or proportional pressure relief).

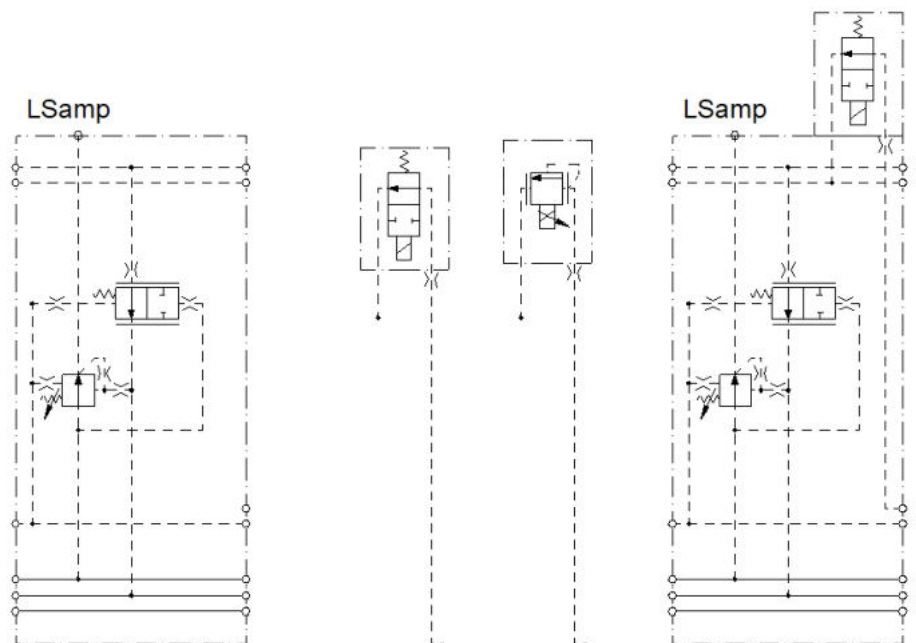
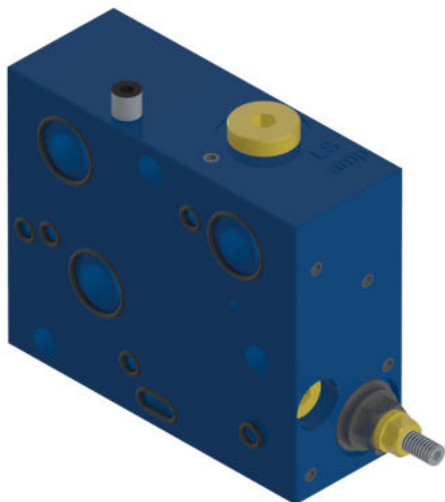

Inlet configuration codes

		10	K	SJ	350	B	-	O	A	-	-
Size											
10	10										
Build type											
K	Sandwich										
Plate version											
UJ	For fixed displacement pump										
SJ	For LS-pump and max. pressure valve in P										
NJ	For LS-pump and LS safety valve										
RJ	For fixed displacement pump and serial connection**										
Pressure adjustment in bar											
350	Max 350 bar										
Port connections											
B	P&T thread in BSP 3/4"										
S	P&T thread in SAE ORB 12										
-											
options LS											
O	Pump unloading function, normally open										
C	Pump unloading function, normally closed										
E	Prop pres relief increase current, increase pressure										
F	Prop pres relief increase current, decrease pressure										
Actuation											
A	12 VDC										
B	24 VDC										
Oring type											
-	HNBR (std)										
	Other oring types on request										
Surface treatment											
-	None (standard)										
A	Protalloy										

** under development



Control section

Control section.

The spools section is the base of the APV-10 control section, it contains the 2-way compensator with delta P adjustment, so the flow can be adjusted without using the stroke limitation.

Each control sections has a handle mechanism, for emergency control, a lever can be mounted if needed. To change between the several control types, a different end cap is used.

Manual control:

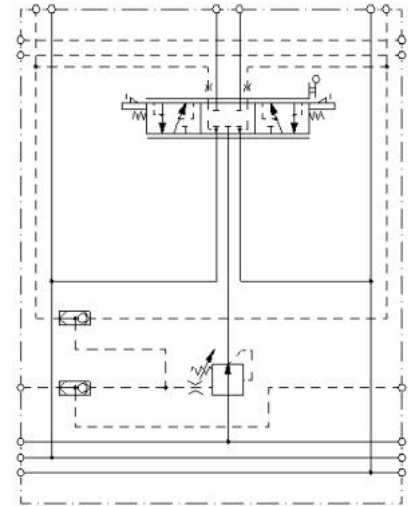
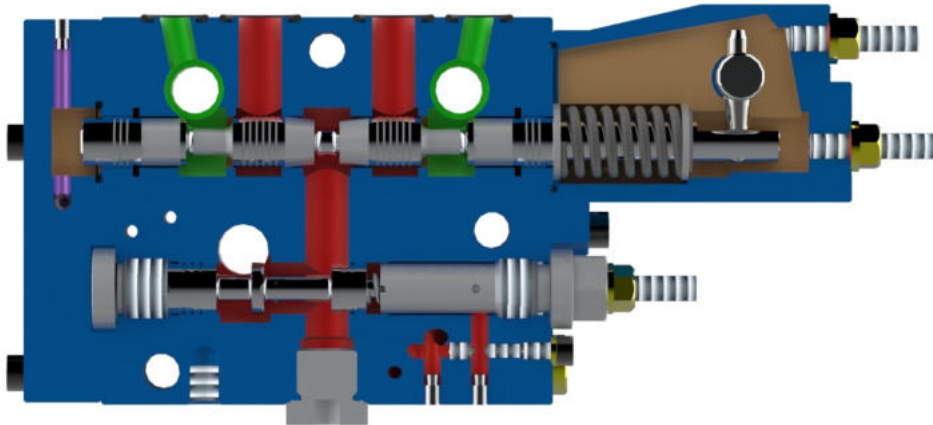

Hydraulic control, end cap with 2 ports 1/4" BSP or 6" SAE ORB

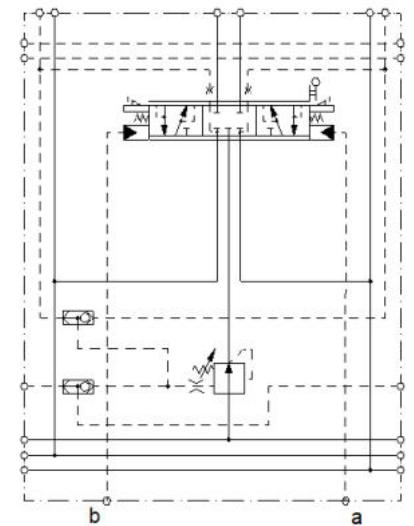
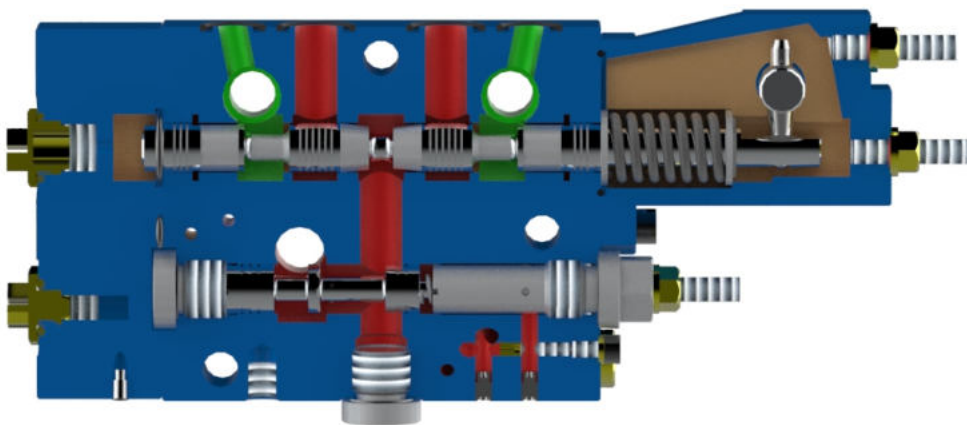

Electric control, end cap with 2 solenoids



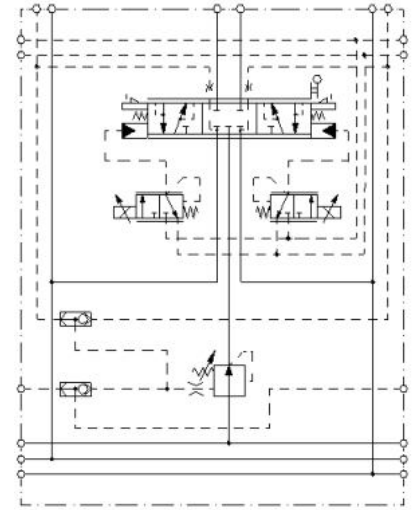
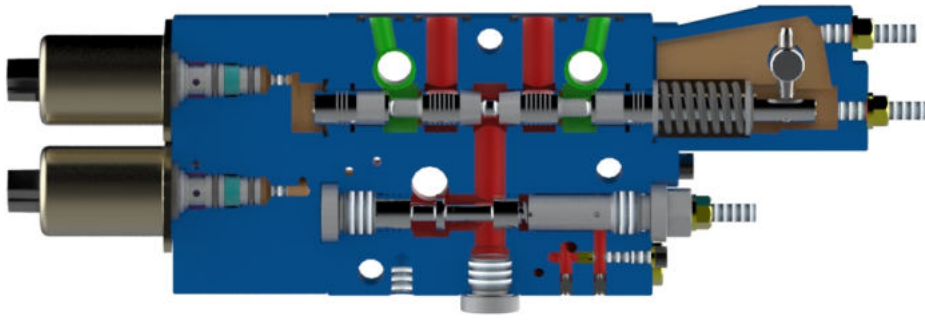

Electric Hydraulic Actuation, Canbus, LVDT cap

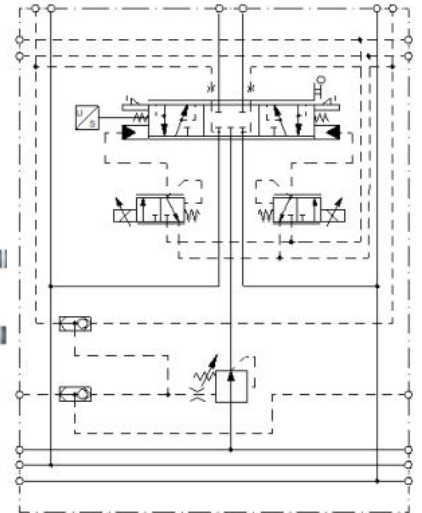
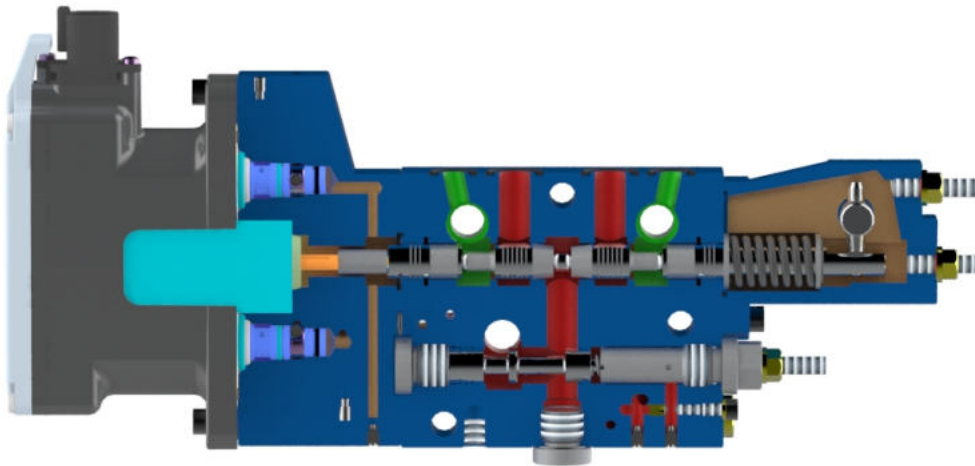

Control spool

There are 2 basic control spools available, the A spool with all ports closed in neutral position and the C spool with P closed and A en B to T in neutral position, with 20% of nominal opening to T. These 2 basic spools have 3 flow ranges, shown below.

- A spool 0-80 l/min: AP-1020-S01-102
- A spool 0-50 l/min: AP-1020-S01-202
- A spool 0-20 l/min: AP-1020-S01-302

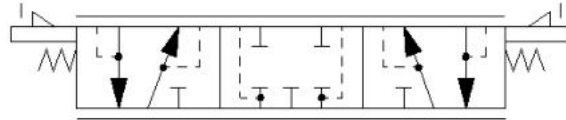

- C spool 0-80 l/min: AP-1020-S01-152
- C spool 0-50 l/min: AP-1020-S01-252
- C spool 0-20 l/min: AP-1020-S01-352

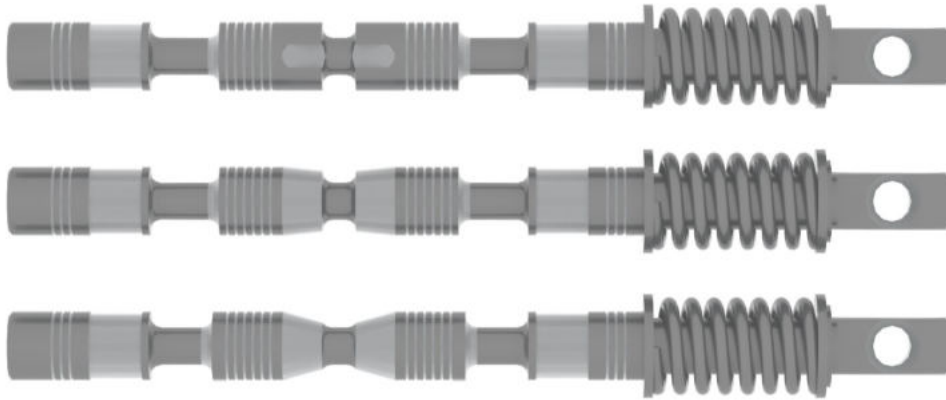
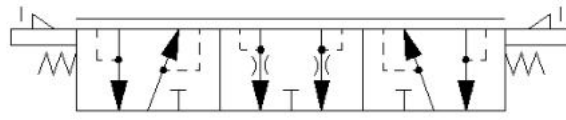

C Spool 0-20 l/min

C Spool 0-50 l/min

A Spool 0-80 l/min

Available upon request are 1:2 / 2:1 ratio spools, for A and C type.

Instead of the basic A and C type B and D type are available upon request.

For B type the B port blocked in neutral;
A port throttled to tank (20%).

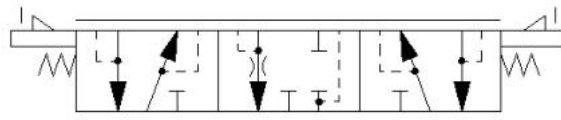

For D type the A port is blocked in neutral;
B port throttled to tank (20%).

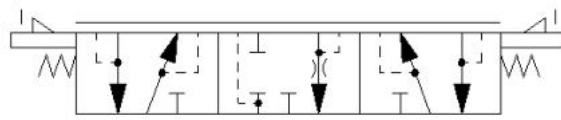

Configuration codes control section (1)

		10	K	F	-	S	S	E	B	A	M
Size											
10	10										
Build type											
K	Sandwich										
Compensator											
F	With compensator										
Body type											
S	Standard body type										
Compensator spring											
S	Standard flow compensator spring										
Control method											
E	For electric or hydraulic control										
O	For Hydraulic control only (port type chosen below)										
H	For manual control										
Actuating type /port type											
B	24VDC										
A	12VDC										
K	Electric Hydraulic Actuator 24 VDC, LVDT **										
J	Electric Hydraulic Actuator 12 VDC, LVDT**										
H	24VDC with II 2G Ex mb II T4, flying lead **										
O	Hydraulic control 1/4" BSP										
P	Hydraulic control SAE ORB 4										
Only in combination with manual control (H)											
F	Spring return										
B	Friction brake (under development) **										
R	3 position detent (under development) **										
Connector type											
A	Amp junior connector										
D	Deutsch connector										
Handle											
-	No handle included										
M	Emergency Lever included with valve										

** under development

Configuration codes control section (2)



Main spool type		C	1- / 1-
A	All ports blocked in neutral		
C	A&B to tank in neutral (20% of nominal flow)		
Max. flow (l/min) (APV-10) A port / B port			
1	80		
2	50		
3	20		
Pre-tension (optional)			
-	None		
x	20 bar		



Connection block

The connection block is the most flexible part of the APV range. There are a few standard versions available.

Basic connection block 'B'

Available with port connections in 1/2" BSP and 10" SAE Oring Boss

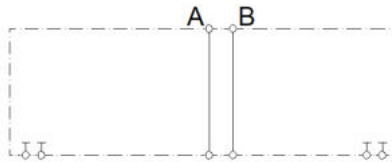
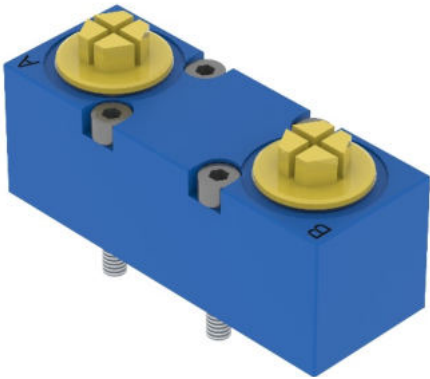

Connection block 'BFY'

Available with port connections in 1/2" BSP en 10" SAE Oring Boss includes Lsa and Lsb adjustments and 'Y' ports on both LS signals 1/8" BSP.

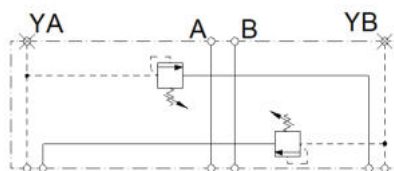

Connection block 'BFLY'

Available with port connections in 1/2" BSP en 10" SAE Oring Boss
 includes Lsa and Lsb adjustments and 'Y' ports on both LS signals in 1/8" BSP
 Adjustable shock-anti cavitation valves can be mounted.

Non-adjustable shock, and or anti cavitation valves are also available for larger qty's or OEM solutions

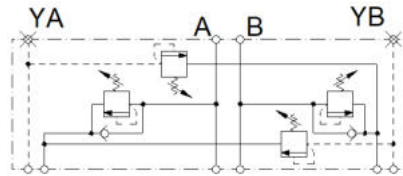

Connection block Customised version

Can be designed according to customer requirement.



Connection block configuration codes

		B	L1	F	Z1 /	Z1	-	-
Port connections								
B	Thread in BSP 1/2"							
S	Thread in SAE ORB, size 10							
Connection block body								
-	Port connections only							
FY	Lsa/Lsb + Y ports							
L1	For shock / suction Z1, with 'Y' port Lsa/b included							
-								
LS pressure setting range								
F	A and B > 100 bar							
Cartridge A-side / B side								
ZW	Shock suction 250-350 bar adjustable							
ZV	Shock suction 170-250 bar adjustable							
ZG	Shock suction 100-170 bar adjustable							
	Lower pressures are on request							
Oring type								
-	HNBR							
	Other oring types on request							
Surface treatment								
-	None (standard)							
A	Protalloy							



End plate

Basic end plate

The basic end plate has no additional ports.

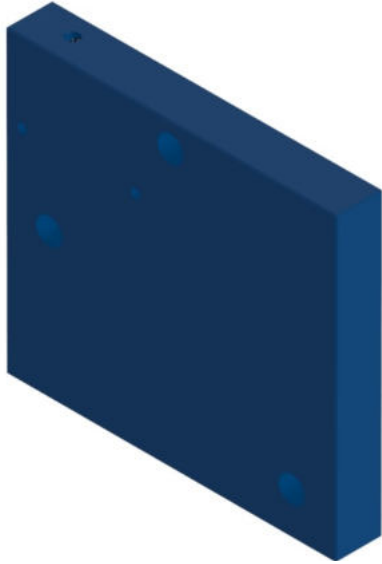

End plate with additional P and T port

This end plate has additional P and T ports in 3/4" BSP.

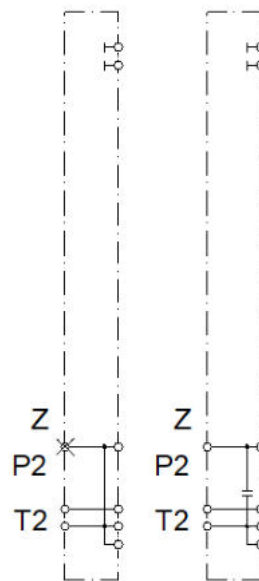
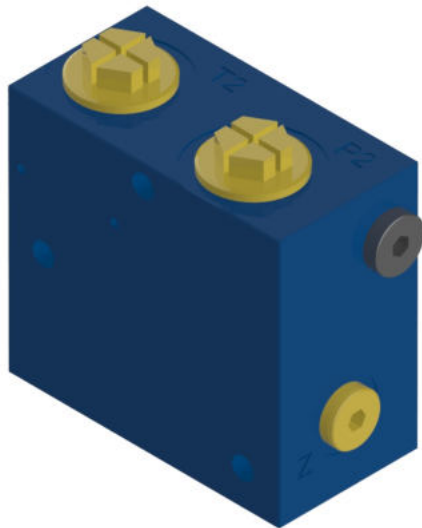

End plate configuration codes

		10	K	PT	Z	B	3	-	-
Size		10							
10	10								
Build type			K						
K	Sandwich								
Plate version				PT					
PT	Including P2 and T2								
PX	Closing plate with no additional ports.								
Variant					Z				
Z	For LS signal from other valve in combination with PT								
Thread type						B			
B	BSP 3/4"								
S	SAE ORB 12"								
Tie Rod kit Length		1-14							
	Amount of sections								
Oring type								-	
-	HNBR								
	Other oring types are on request								
Surface treatment									-
-	None (standard)								
A	Protalloy								



General dimensions (in mm)

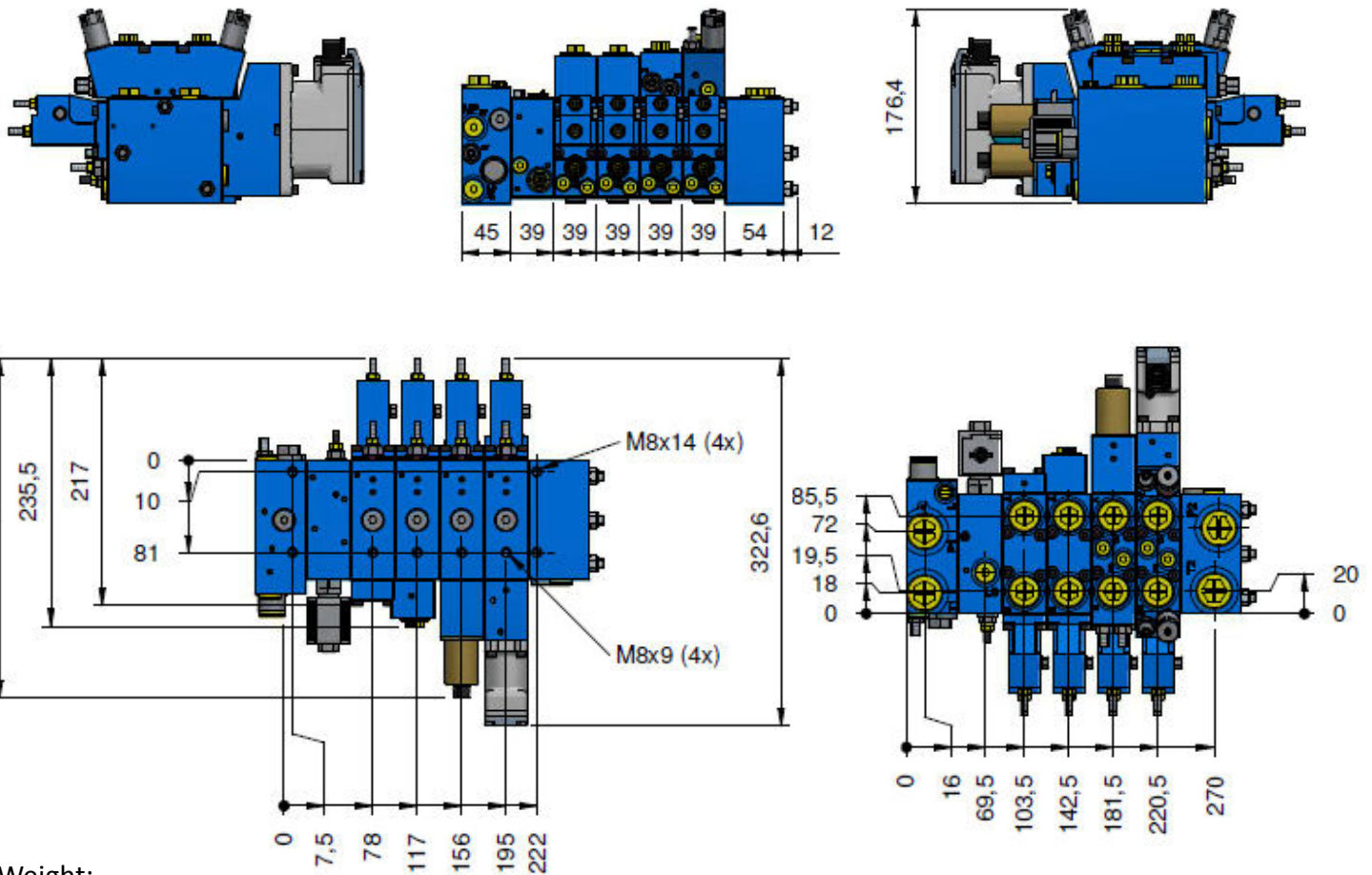

Weight:

Inlet plate NJ	3,6kg
Inlet plate U/S J	3,5kg
Endplate PT	3,4kg
Endplate PX	1,0kg
Manual control section	3,0kg
Hydraulic control section	3,3kg
Electric control section	4,2kg
EHA control section	3,6kg
Connectionblock B;	0,9kg
Connectionblock BFY	0,5kg
Connectionblock BFL;	0,6kg

4-sectional valve like shown above: 25,2 kg



Performance curves.

Q-I curve

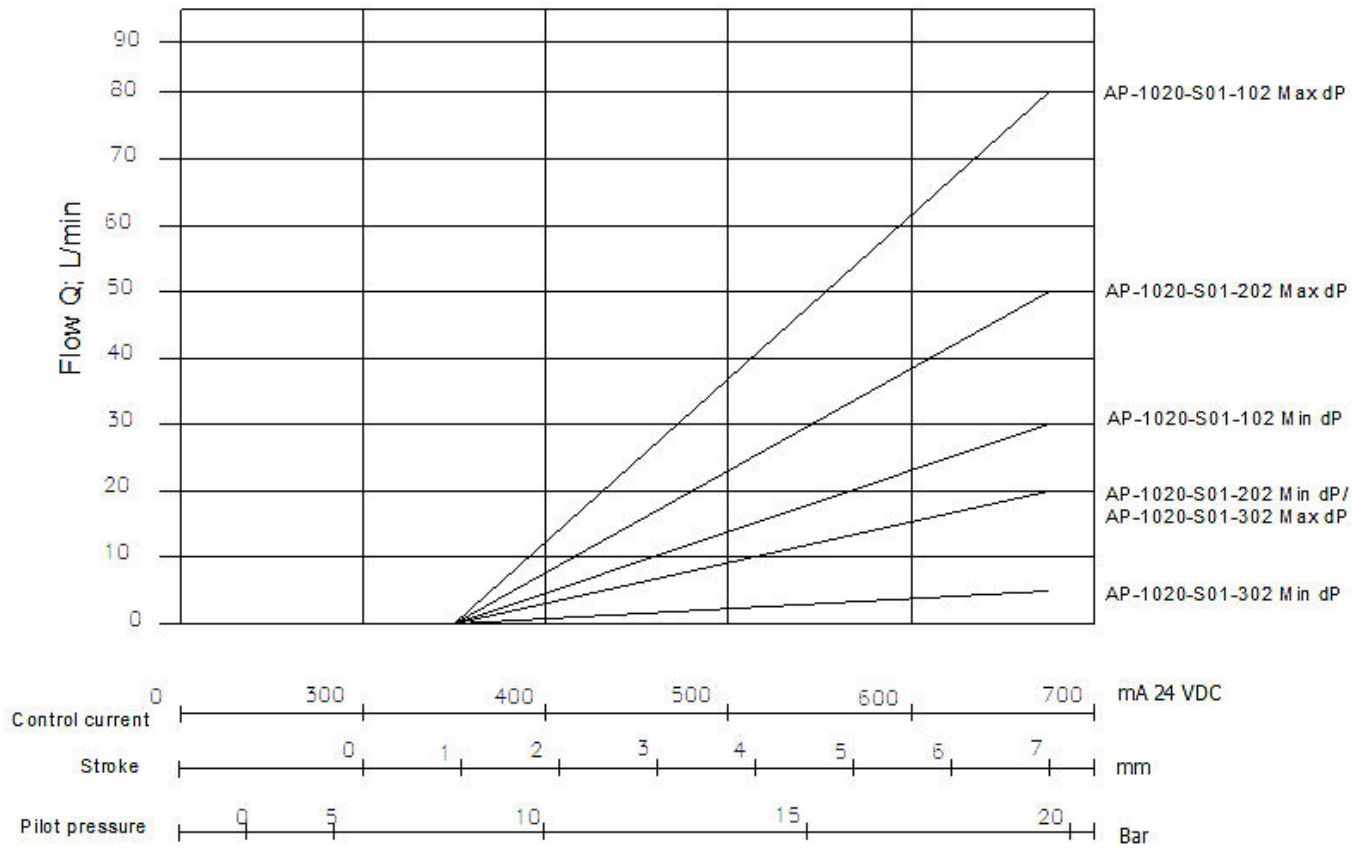

P/q curve



p-q curve

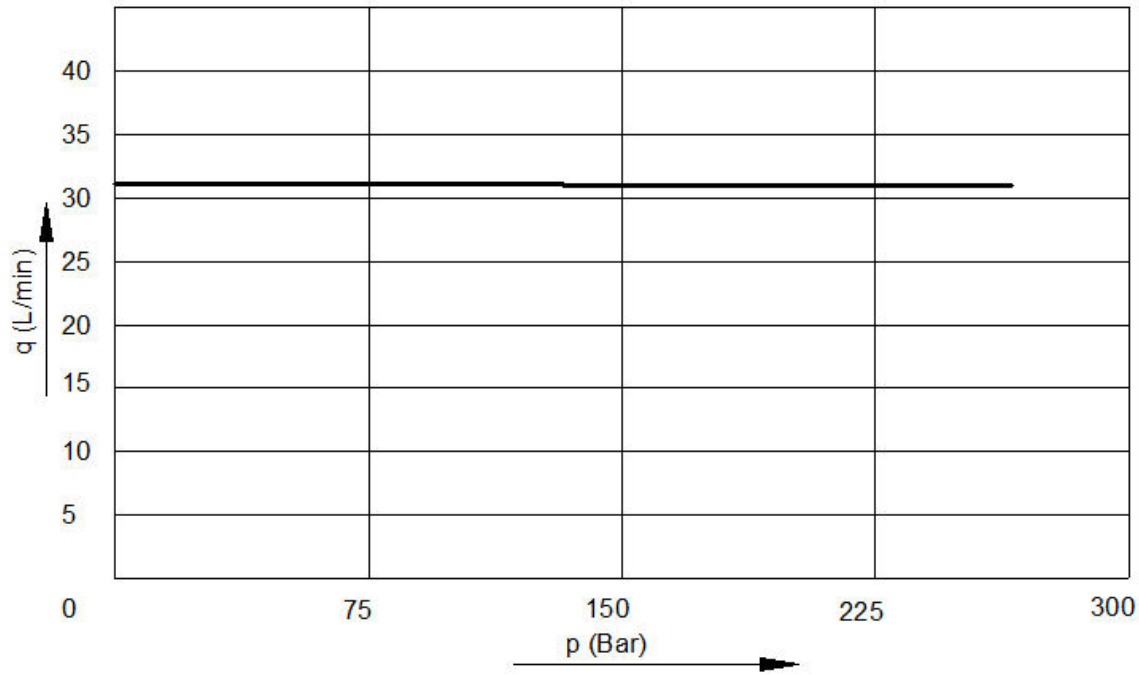

Pressure drop A/B > T1

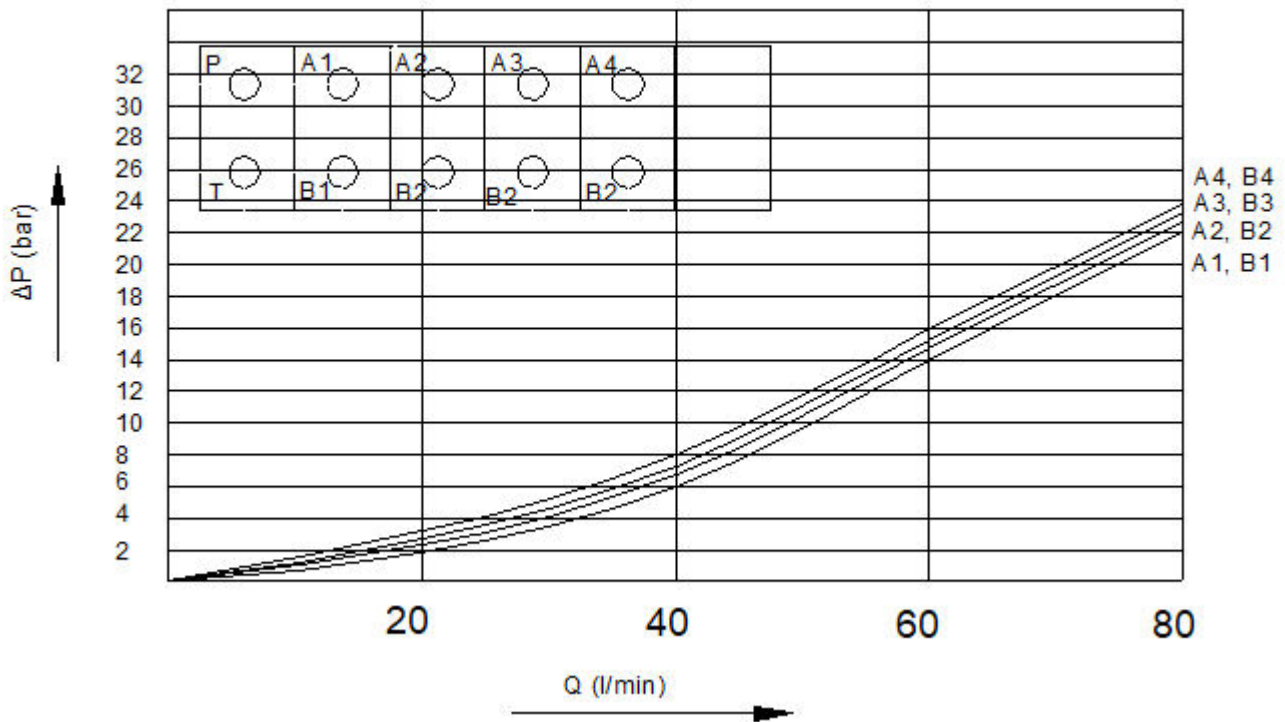

Pressure drop A/B > T1&T2

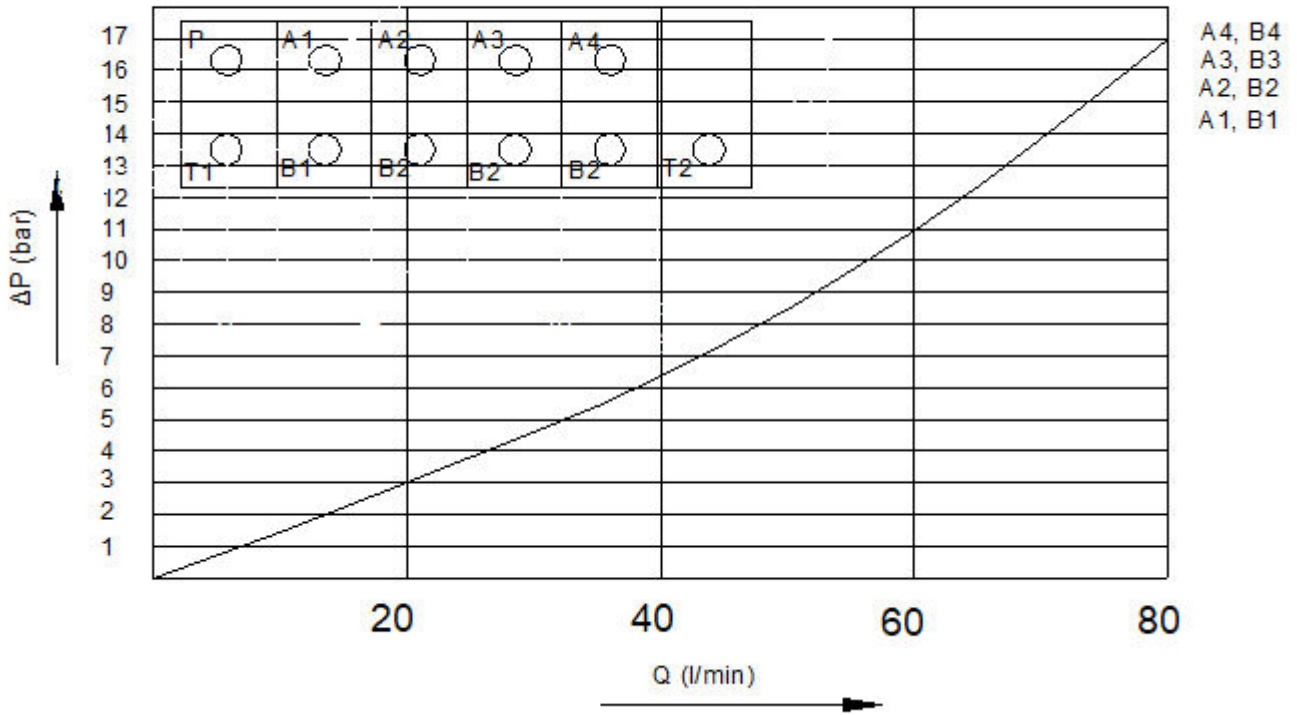

Pressure drop P > T1

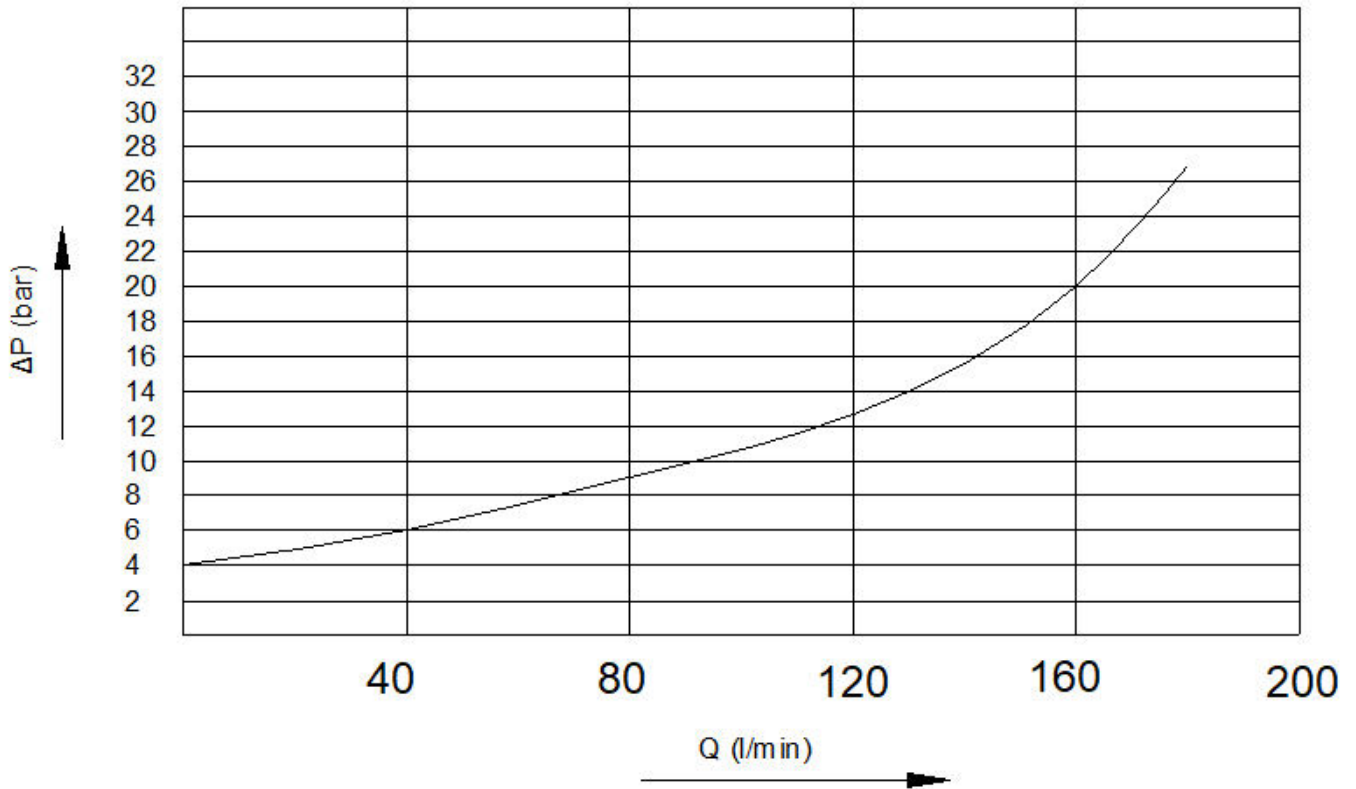

Recommended spare parts breakdown

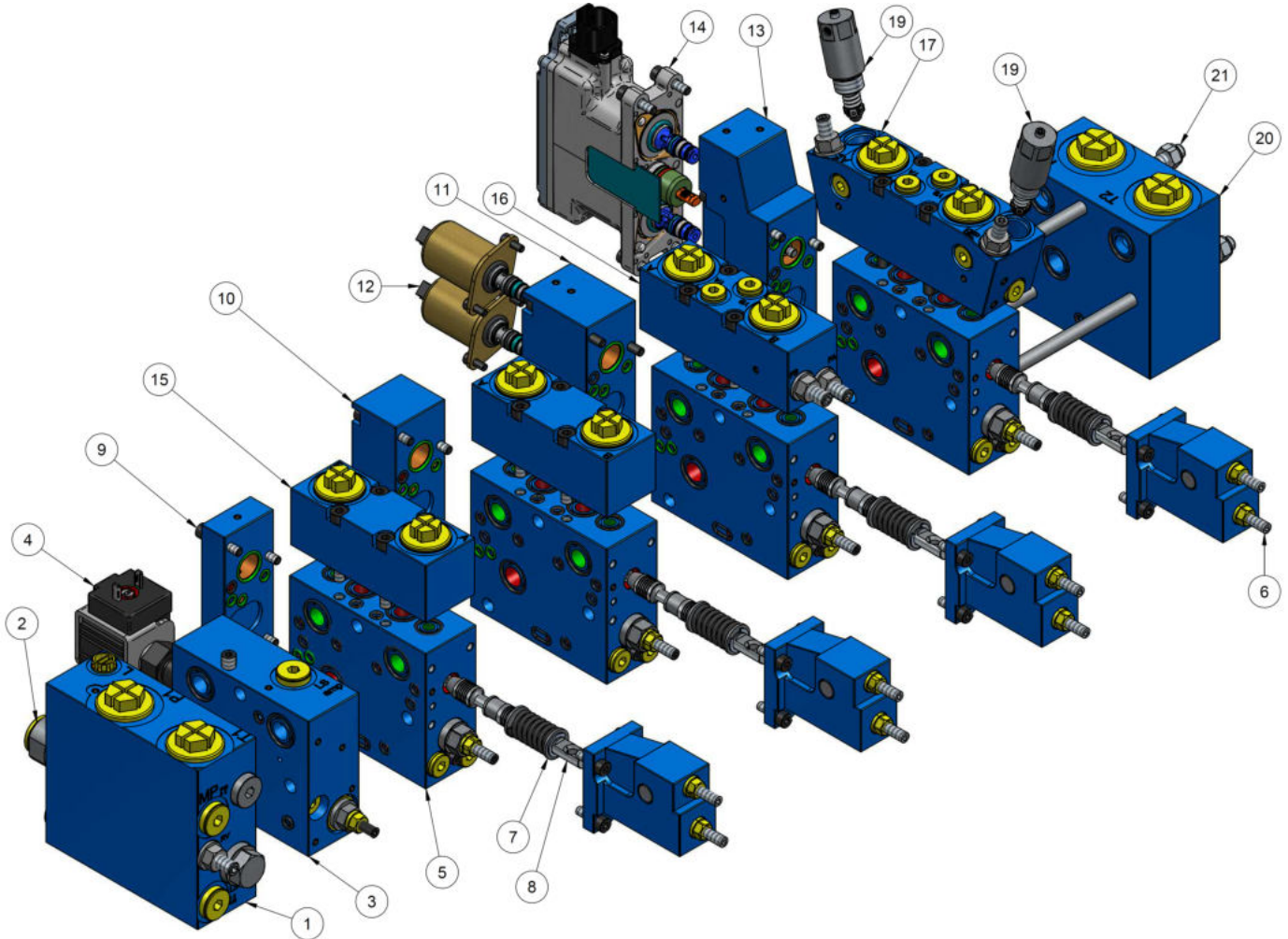

- | | |
|------------------------|--|
| 1. AP-1010-302U/S/N | Inlet plate |
| 2. AP-1640-002-393 | Pressure reducing valve |
| 3. AP-1010-303 | Option A&L |
| 4. AP-1610-364D/E | Pump unloading or proportional pressure relief |
| 5. AP-1020-300F | Spool section F |
| 6. AP-1020-303 | Handle mechanism |
| 7. AP-1020S000E | Spring |
| 8. AP-1020-S01-102/152 | Spool A or C |
| 9. AP-1020-302 | End cap manual control |
| 10. AP-1020-301 | End cap hydraulic control |
| 11. AP-1020-304 | End cap electric control |
| 12. AP-1020-356A/B | Solenoid |
| 13. AP-1020-305 | End cap for EHA |
| 14. AP-1020-356J | EHA module |
| 15. AP-1030-300 | Connection block B |
| 16. AP-1030-301 | Connection block BFLY |
| 17. AP-1030-303 | Connection block BFY |
| 18. ZC-0220-016 | Relief and anti-cavitation |
| 19. ZC-0220-020G/V/W | Shock suction |
| 20. AP-1040-303/304 | End plate |
| 21. AP-1020-309K1/14 | Tie rod kit |





HPV b.v.

A. Einsteinlaan 27
9615 TE Kolham
The Netherlands

T: +31 (0) 598 - 22 70 80

E: sales@hvp-nl.com

www.hpv-nl.com